

SERVICE BULLETIN

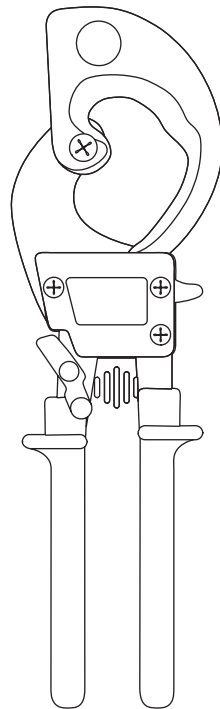



45207 Ratchet Cable Cutter





Read and understand all of the instructions and safety information in this manual before operating or servicing this tool.

IMPORTANT SAFETY INFORMATION

	<p>SAFETY ALERT SYMBOL</p>
<p>This symbol is used to call your attention to hazards or unsafe practices which could result in an injury or property damage. The signal word, defined below, indicates the severity of the hazard. The message after the signal word provides information for preventing or avoiding the hazard.</p>	
<p>⚠ DANGER</p>	
<p>Immediate hazards which, if not avoided, WILL result in severe injury or death.</p>	
<p>⚠ WARNING</p>	
<p>Hazards which, if not avoided, COULD result in severe injury or death.</p>	
<p>⚠ CAUTION</p>	
<p>Hazards or unsafe practices which, if not avoided, MAY result in injury or property damage.</p>	

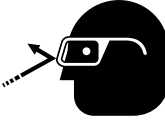
	<p>⚠ WARNING</p>
	<p>Electric shock hazard: This tool is not insulated. Contact with live circuits could result in severe injury or death.</p>

	<p>⚠ WARNING</p>
	<p>Wear eye protection when operating or servicing this tool. Failure to wear eye protection could result in serious eye injury from flying debris.</p>

	<p>⚠ WARNING</p>
	<p>Keep hands and fingers clear of blades. Failure to observe this warning could result in severe injury or death.</p>

Note: Keep all decals clean and legible, and replace when necessary.

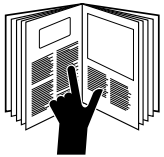
	<p>⚠ WARNING</p>
	<p>Read and understand all of the instructions and safety information in this manual before operating or servicing this tool. Failure to observe this warning could result in severe injury or death.</p>

All specifications are nominal and may change as design improvements occur. Greenlee Textron Inc. shall not be liable for damages resulting from misapplication or misuse of its products.

KEEP THIS MANUAL

Specifications

Length: 11" (279 mm)

Jaw Opening: 2" (50 mm)

Capacity

	Maximum	Frequent Use
Copper	750 kcmil (MCM) (400 mm ²)	600 kcmil (MCM) (300 mm ²)
Aluminum	1000 kcmil (MCM) (500 mm ²)	750 kcmil (MCM) (400 mm ²)
Communications Cable	2" diameter (50 mm ²)	—

IMPORTANT

Do not cut ACSR or steel.

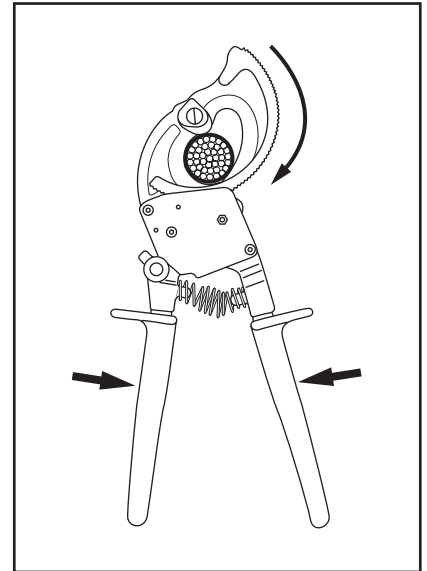
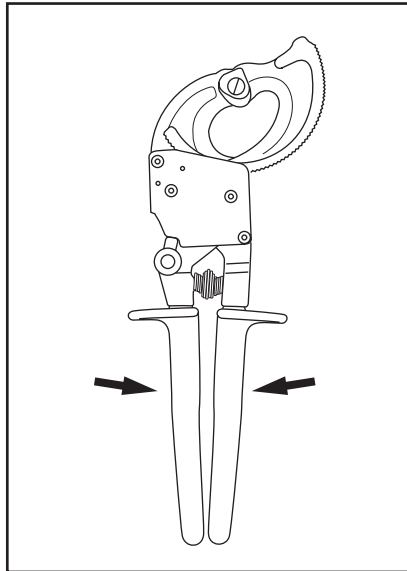
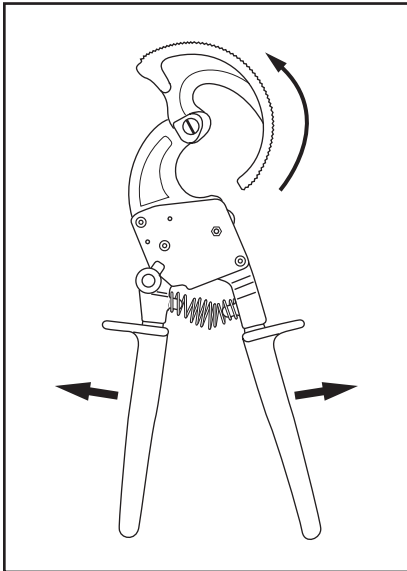
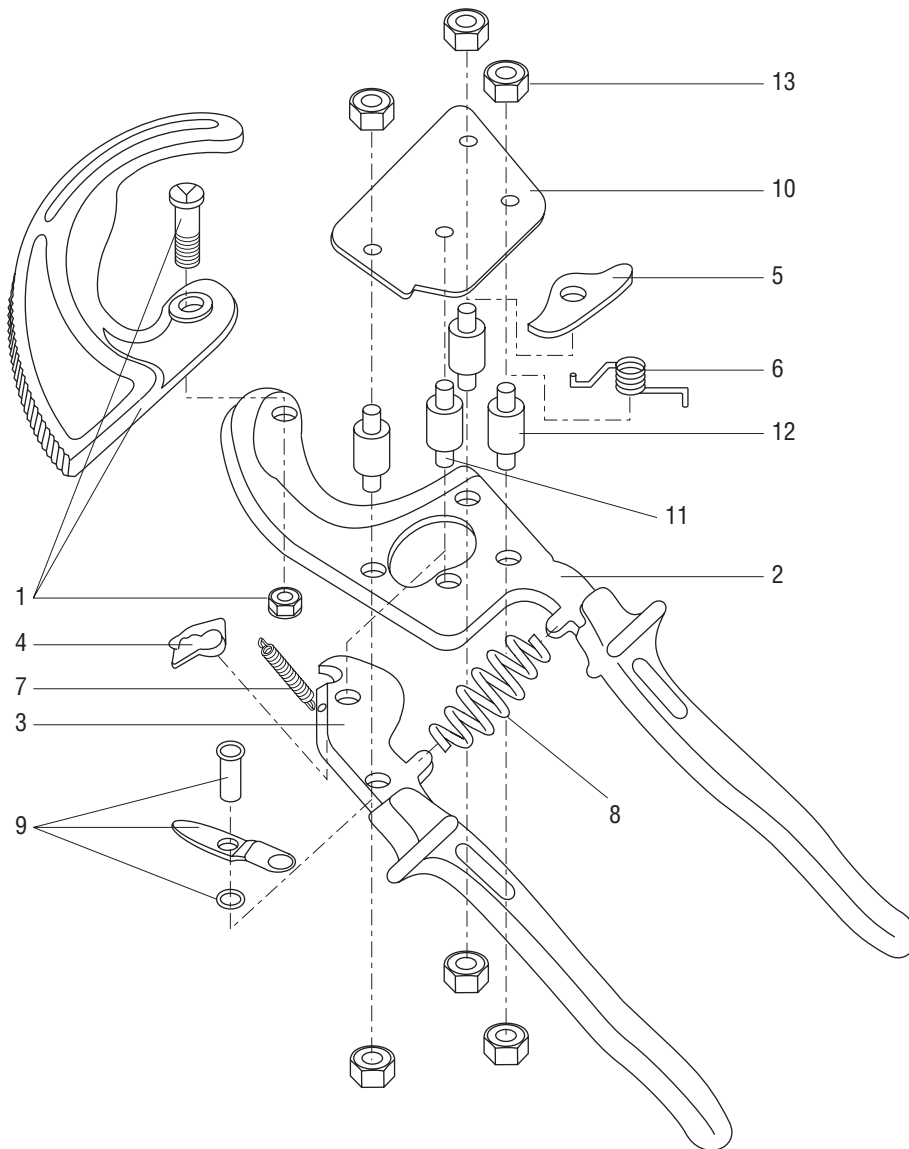

Illustration and Parts List



Key	Part No.	Description	Qty
1	504 5211.2	Movable blade set	1
2	504 5228.2	Fixed blade/handle	1
3	504 5217.1	Movable handle	1
4	504 5237.1	Drive pawl	1
5	504 5220.7	Release lever	1
6	504 5221.5	Torsion spring	1
7	504 5222.3	Pawl spring	1
8	504 5216.3	Handle spring	1
9	504 5223.1	Locking lever set	1
10	504 5238.0	Front plate	1
11	504 5225.8	Pivot pin	1
12	504 5239.8	Threaded male pin	3
13	504 5268.1	Nut	6



USA 800-435-0786 Fax: 800-451-2632
 815-397-7070 Fax: 815-397-1865
 Canada 800-435-0786 Fax: 800-524-2853
 International +1-815-397-7070 Fax: +1-815-397-9247

4455 Boeing Drive • Rockford, IL 61109-2988 • USA • 815-397-7070
 An ISO 9001 Company • Greenlee Textron Inc. is a subsidiary of Textron Inc.

www.greenlee.com

Printed in USA